

Operating instructions

Klafs SaunaPUR with 18029 controller

KLAFS
MY SAUNA AND SPA

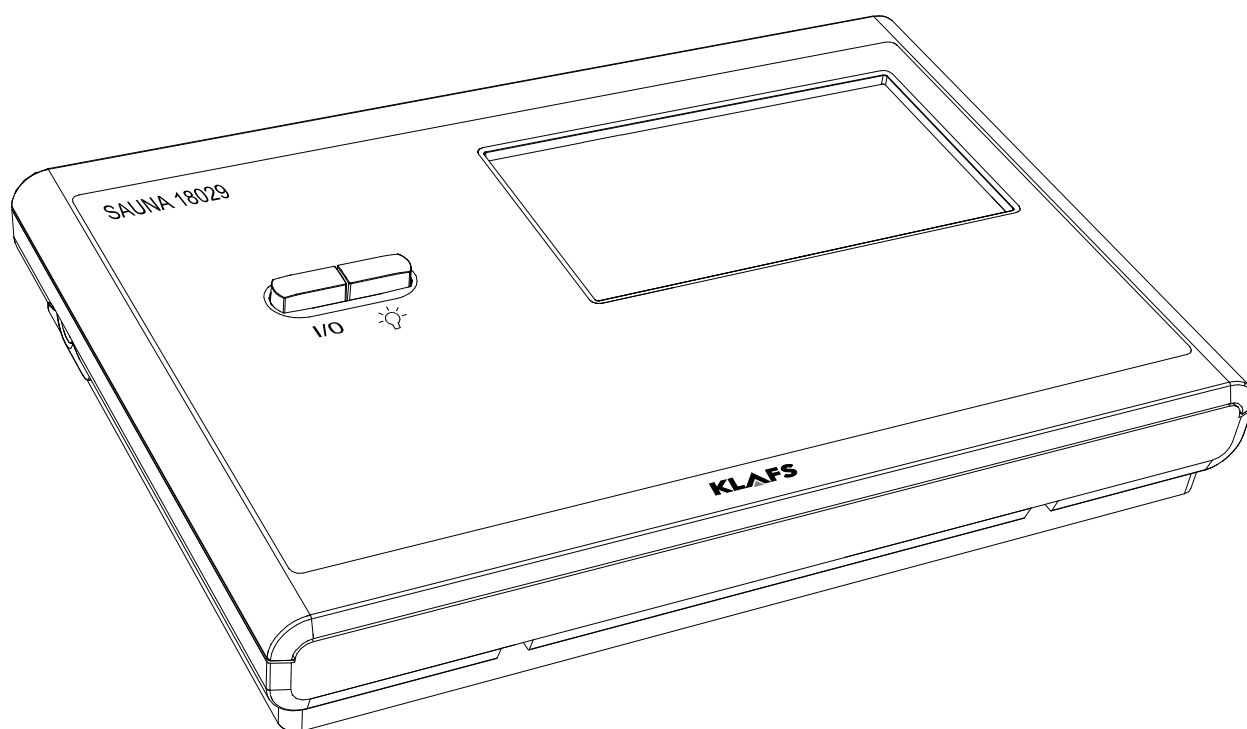

Contents

Page

| | | |
|------------|--|-----------|
| 1. | Quick guide - SaunaPUR controller | 4 |
| 2. | Bathing modes | 5 |
| 2.1. | Sauna | 5 |
| 2.2. | InfraPLUS (optional) | 5 |
| 3. | Technical data | 5 |
| 4. | Intended use | 6 |
| 5. | Safety precautions for infrared emitter | 6 |
| 6. | General safety information | 7 |
| 7. | Controller | 8 |
| 7.1. | Operating and display elements | 8 |
| 7.2. | Touchscreen - Overview | 9 |
| 7.3. | Touchscreen - Basic operation and display symbols | 10 |
| 7.4. | Touchscreen - Section 1: Cabin control with door contact switch (optional) | 11 |
| 7.5. | Touchscreen - Section 1: Cabin control without door contact switch | 12 |
| 7.6. | Touchscreen - Section 2: Bathing modes | 13 |
| 7.7. | Touchscreen - Section 3: Status bar | 14 |
| 7.8. | Touchscreen - Section 4: Digital display of bathing parameters, digital display of preset time mode, ready-to-use symbol | 15 |
| 7.9. | Touchscreen - Section 5: Special features, cabin light, clock | 16 |
| 7.10. | Touchscreen - Section 6: Parameter input, controller with bar scale | 17 |
| 7.11. | Touchscreen - Section 7: Programs, bathing parameters, preset time mode | 17 |
| 8. | Basic functions and settings | 18 |
| 8.1. | Switching the power supply on/off at the main switch | 18 |
| 8.2. | Switching the cabin light on/off | 19 |
| 8.3. | Setting the time | 20 |
| 8.4. | Standby mode | 21 |
| 9. | Operation | 22 |
| 9.1. | Sauna mode | 22 |
| 9.2. | PUR bathing mode | 23 |
| 9.3. | InfraPLUS mode (optional) | 24 |
| 9.4. | Remote power-on unit (optional) | 27 |
| 9.5. | Interior display (optional), with SaunaPUR button, with/without IR receiver | 28 |
| 9.6. | Green Sauna button | 30 |
| 9.7. | WELLCONTROL (optional) | 31 |
| 10. | Custom settings | 33 |
| 10.1. | Selecting the standard/custom program | 33 |
| 10.2. | Setting the temperature | 34 |
| 10.3. | Setting InfraPLUS (optional) | 34 |
| 10.4. | Setting the bathing time | 35 |
| 10.5. | Setting preset time mode | 35 |
| 10.6. | Setting a new password for the touchscreen lock | 36 |
| 10.7. | Switching the touchscreen lock on/off | 37 |
| 10.8. | Special features | 38 |
| 10.9. | Climate Manager (optional) | 39 |
| 10.10. | Vent flap for airing and ventilating the cabin (optional) | 39 |
| 11. | If something does not work | 40 |
| 11.1. | Error messages on the display | 40 |
| 11.2. | Other possible errors | 41 |
| 11.3. | Resetting the error message | 44 |
| 12. | Cleaning and maintenance | 45 |
| 12.1. | Cleaning the sauna cabin | 45 |
| 12.2. | Cleaning the touchscreen | 45 |

| Contents | Page |
|--|-------------|
| 12.3. Cleaning the InfraPLUS seat | 46 |
| 12.4. Cleaning the InfraPLUS reflector | 47 |
| 13. Addresses | 48 |

1. Quick guide - SaunAPUR controller

The Klafs SaunAPUR controller enables you to operate your sauna quickly and easily. There are three preset standard programs for the bathing mode (Sauna). Any changes made to the standard program settings are saved in a custom program.



Only operate the touchscreen with your fingers. Operating the touchscreen with hard objects will leave scratches on the screen's surface or damage the screen.



Entering and changing settings will be quicker if a short pause of around 0.5 seconds is left between presses.



After five minutes of non-use, the backlighting will gradually start to dim and then the screen will switch off fully within a minute. If you touch the display while it is dimmed or switched off, the backlighting will switch on first. You will then be able to operate the controller via the display.

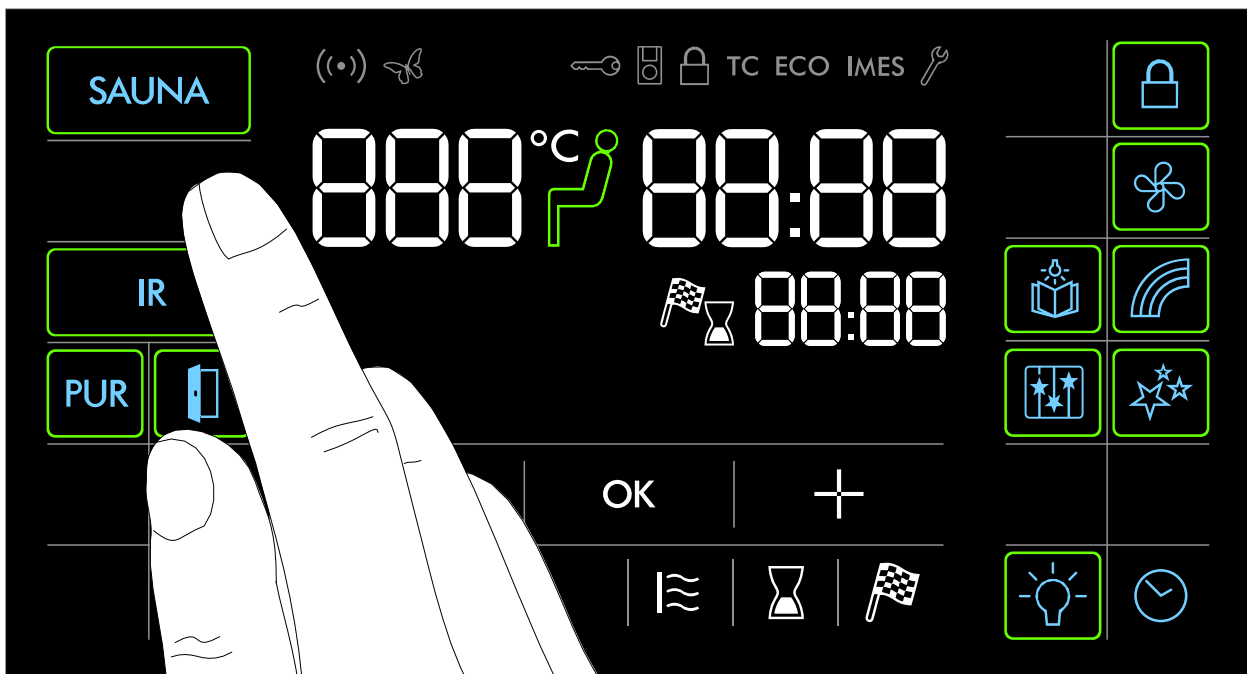

2. Bathing modes



All bathing modes in your Klafs Sauna have been designed to improve your general health and well-being.

However, you should still take into account any pre-existing health conditions when choosing your bathing program.

This includes:

- Temperature
- Infrared heat (optional)
- Bathing time.

Choose your bathing program according to its length and your condition. You should end the session and leave the cabin if you start to feel unwell.

2.1. Sauna

Sauna

with temperatures of 85 - 100 °C and a low relative humidity.

SaunaPUR

Klafs new development brings back the tradition of Finnish stone steam baths.

With around 100 kg of olivine stones in the sauna heater, the sauna baths are even more comfortable, and the heat infusions are more intensive. Using the SaunaPUR, you can experience the feeling of an authentic Finnish sauna.

The sauna must be pre-heated to 70 - 85 °C long before use. When the bathing session begins, the sauna heater is switched off using the SaunaPUR function.

The slowly decreasing temperature is counterbalanced by regular heat infusions. Using the new bathing mode, it is possible to bathe in a sauna without switching noises and with reduced electromagnetic radiation.

Warm air bath

with a particularly mild climate, temperatures of 45 - 60 °C and a relative humidity of up to approx. 20 %.

2.2. InfraPLUS (optional)

Infrared heat

with an ambient temperature of 20 - 40 °C and variable intensity of 1 - 10 for the back heater (41 - 43 °C).

You can also set the back heater to heat for between 10 - 30 minutes.

3. Technical data

Controller type 18029: 3/N/PE ~400 V, max. 9 kW.

Optional InfraPLUS: 1/N/PE ~230 V, max. 350 W per InfraPLUS unit.

Ambient conditions: Temperature 0 °C to 35 °C, max. relative humidity 80 %.

4. Intended use

The controller is intended for use with the heaters tested and approved by the German VDE (Association for Electrical, Electronic and Information Technologies) or TÜV (Technical Inspection Authority):

- Sauna heater with or without evaporator
- InfraPLUS (optional).

The controller is only to be used as intended. Intended use also assumes adherence to the instructions for operation, installation and servicing as prescribed by the manufacturer. The manufacturer is not responsible for any damage resulting from unintended use or unapproved changes to the controller. The user does these things at their own risk.

The controller may only be operated, maintained and repaired by persons who are familiar with it and aware of the risks involved. Always observe the relevant German VDE regulations and other generally recognised safety precautions.

5. Safety precautions for infrared emitter

Note the following information before using infrared emitters.

- Do not use the infrared cabin within 24 hours of being exposed to UV radiation from an artificial source or sunbathing.
 - Consult a doctor before using the infrared heat cabin if you are at risk of overheating or if you suffer from cardiovascular diseases.
 - Seek medical advice to avoid triggering erythema ab igne as a result of exposure to infrared radiation. Do not expose yourself to the radiation again if the erythema becomes chronic (the skin stays red for longer than one day) or if reticulated colour changes remain after regular exposure to infrared radiation.
 - Do not use the infrared cabin if you have reduced sensitivity to heat, have consumed alcohol or have taken sedatives.
-

6. General safety information

Read and observe the operating instructions and safety precautions before commissioning.

- Disconnect the controller from the mains before opening the controller housing.
 - The controller may only be connected to the mains by a locally authorised electrician.
 - Only connect the sauna unit directly to the mains voltage via a fixed connection in accordance with VDE regulations. Use a residual-current breaker $I_{\Delta N} \leq 0.03 \text{ A}$ with at least 3-mm contact opening in the connecting feed line.
 - Contact Klafs customer service if faults cannot be rectified by a qualified electrician.
 - Remote activation (remote power-on unit): Setting, controlling and/or adjusting the controller using a command or a remote control unit performed outside of the range of vision of the sauna heater. Remote activation (remote power-on unit) may be used only together with the safety-contact switch (SCS) or the Bonatherm under-bench heater.
 - Only use original Klafs spare parts.
 - Unapproved changes to the controller are not permitted.
 - Install the controller in accordance with the installation instructions.
 - Electrical wiring inside the cabin and the cabin walls must have silicone insulation.
 - Before commissioning the controller, always make sure that there are no flammable objects near the sauna heater or infrared heater in the cabin. **RISK OF FIRE!**
 - Do not use the sauna to dry your washing.
 - Never use undiluted essential oils. Only use the indicated concentration (approx. 20-30 drops of oil in one litre of water).
 - Only use Klafs essential oil extracts.
 - Never store the bottle containing the essential oil inside the sauna cabin.
 - Regularly check the sauna heater for damage.
 - Check the heater for flammable objects before restarting the timer or switching on the heater via a separate remote activation system.
 - The unit can be used by children over eight years of age, by people with reduced physical, sensory or mental capabilities and by people who lack experience/knowledge in using it provided that they are supervised while doing so and/or have been shown how to use the cabin safely and understand the potential risks involved. Do not allow children to play in the unit. Children should not clean the cabin or carry out basic maintenance on it without supervision.
-

7. Controller

7.1. Operating and display elements

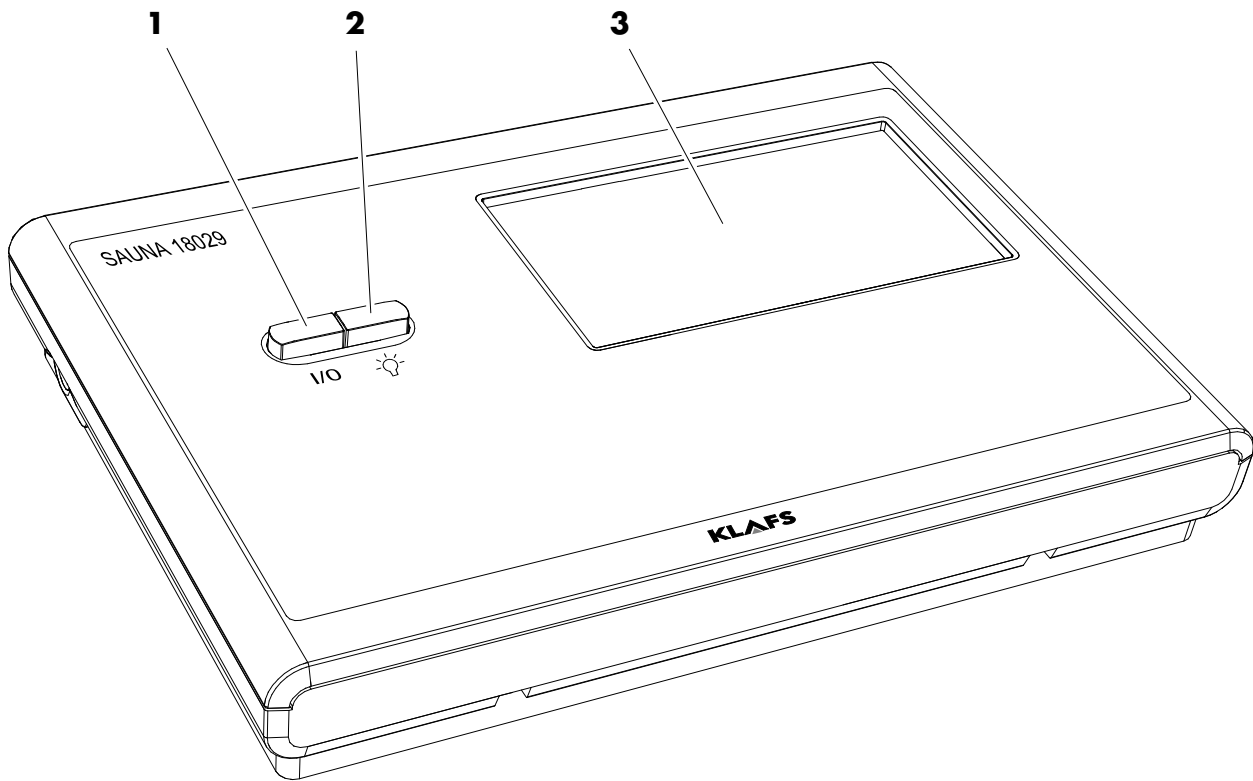

| Item | Description |
|------|--|
| 1. | <p>Controller main switch.</p> <ul style="list-style-type: none"> ☞ The main switch switches off the mains power to the controller. ☞ The internal clock has a power reserve for a few months in the event of a power failure. |
| 2. | <p>Cabin light switch.</p> <ul style="list-style-type: none"> ☞ When the controller is connected to the mains, the cabin light may be switched on independently of the main switch. |
| 3. | <p>Touchscreen.</p> <ul style="list-style-type: none"> ◆ See page 9. |

7. Controller

7.2. Touchscreen - Overview

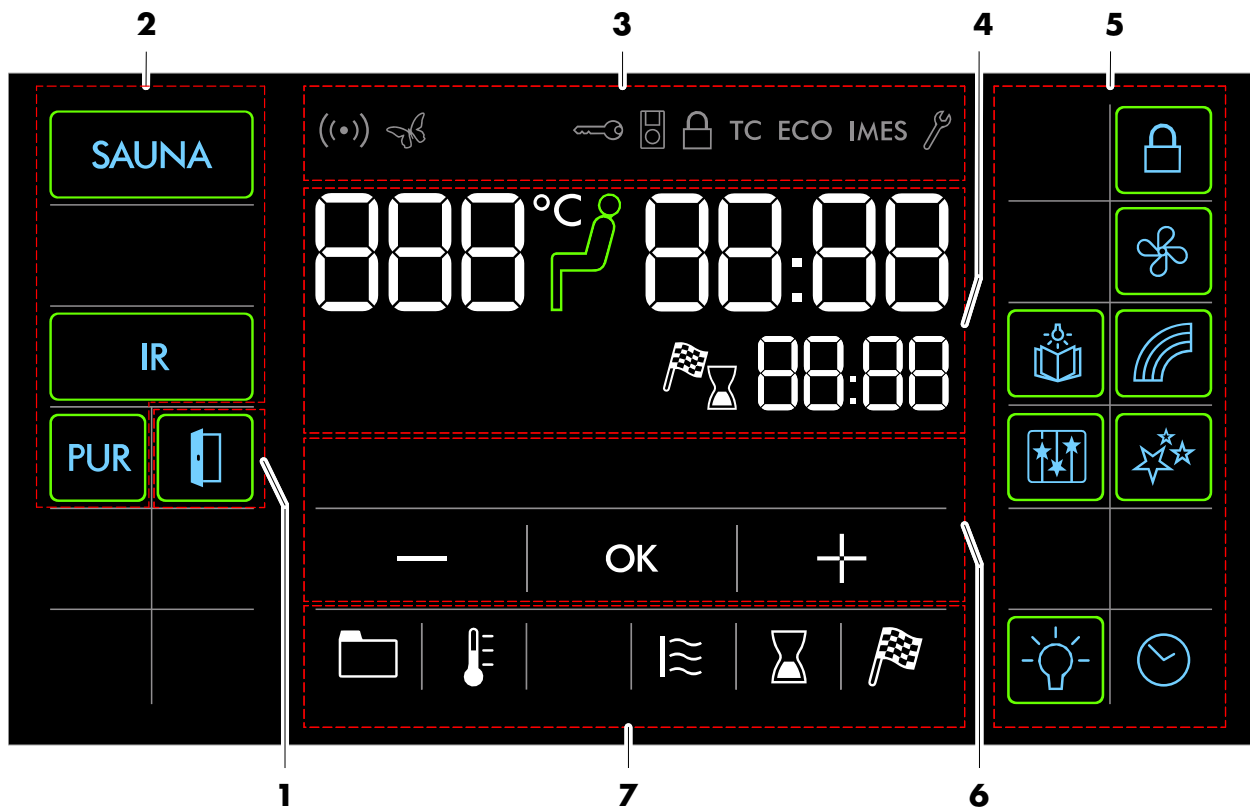

| Section | Description |
|---------|---|
| 1. | Cabin control (optional). <ul style="list-style-type: none"> ☞ Function for remotely controlling the controller via the Klafs Sauna smartphone app. ◆ See page 11. |
| 2. | Bathing mode. <ul style="list-style-type: none"> ◆ See page 13. |
| 3. | Status bar. <ul style="list-style-type: none"> ☞ Display only, no touchscreen function. ☞ The symbol display depends on the configuration. ◆ See page 14. |
| 4. | Digital display of bathing parameters, digital display of preset time mode, ready-to-use symbol. <ul style="list-style-type: none"> ◆ See page 15. |
| 5. | Special features, cabin light, clock. <ul style="list-style-type: none"> ☞ The symbol display depends on the configuration. ◆ See page 16. |
| 6. | Controller with bar scale, parameter input. <ul style="list-style-type: none"> ◆ See page 17. |
| 7. | Program, bathing parameters, preset time mode. <ul style="list-style-type: none"> ◆ See page 17. |

7. Controller

7.3. Touchscreen - Basic operation and display symbols



The control panel must be switched on at the main switch.
 ▶ See page 18.



Operate the control panel by pressing on the touchscreen with your finger.
 The touchscreen is divided into display sections and function symbols.
 Functions are activated by pressing the symbols displayed.
 Entering and changing settings will be quicker if a short pause of around 0.5 seconds is left between presses.







When settings that can be changed are selected, they flash at a frequency of 1 Hz.
 The controller will automatically cancel input mode and retain the existing setting if no symbol is pressed or the altered setting is not confirmed by pressing the OK symbol within five seconds.





After five minutes of non-use, the backlighting will gradually start to dim and then the screen will switch off fully within a minute.
 If you touch the display while it is dimmed or switched off, the backlighting will switch on first. You will then be able to operate the controller via the display.

Example

| Symbol: | Display/function: |
|---|---|
|  | Symbol. e.g. a word, icon or number. Pressing a symbol executes the relevant function. |
|  | Backlit ring. Indicates that a function has been activated or started. Pressing the relevant symbol again deactivates or stops the function or allows the settings to be changed. |
|  | Numerical value. A numerical value that can be changed flashes. Touching the value allows you to change it. Increase or decrease the value by pressing the "+" or "-" symbol. Confirm any changes by pressing the OK symbol. ⓘ The controller will automatically cancel input mode and retain the existing setting if the altered setting is not confirmed by pressing OK within five seconds. |
|  | Bar scale. Increase or decrease the value on the bar scale by pressing the "+" or "-" symbol. Or touch the bar scale to change it in the same way as for numerical settings. Confirm any changes by pressing the OK symbol. ⓘ The controller will automatically cancel input mode and retain the existing setting if the altered setting is not confirmed by pressing OK within five seconds. |



7. Controller

7.4. Touchscreen - Section 1: Cabin control with door contact switch (optional)

| Symbol: | Display/function: |
|---|---|
|  | <p>The cabin control function for operating the controller via the Klafs Sauna app is only available for cabins that have WLAN installed and activated.</p> <p>▶ See page 14 for the WLAN function.</p> |
|  | <p>Cabin control.</p> <ul style="list-style-type: none"> ☞ Function for operating the controller via the Klafs Sauna app, e.g. with a smartphone. ☞ Klafs safety concept ASC. <p>Performs a visual precheck of the inside of the cabin to ensure that there are no flammable objects near the sauna heater or the infrared heater. Notice: The cabin can only be started via the Klafs Sauna app if this visual check has been carried out after the last sauna session.</p> <p>▶ Standby mode. See page 21 for the function for remotely controlling the controller via the Klafs Sauna app.</p> <p>Backlit ring is flashing: The backlit ring will start flashing after you have pressed the cabin control symbol. Open the sauna door within the next 30 minutes and check the heaters for flammable objects, removing any if necessary. The backlit ring will be permanently lit after closing the sauna door. The cabin can now be started via the Klafs Sauna app.</p> <p>Backlit ring is permanently lit: The sauna cabin has been checked. A bathing mode can be started via the Klafs Sauna app.</p> <p>Backlit ring is off: If the sauna door is opened after the visual precheck and before the session has started, the backlit ring will go out. The cabin can no longer be operated via the Klafs Sauna app. If the sauna door is opened during the remote-control standby period and the cabin temperature is less than 40 °C, the backlit ring will go out and the controller must be reset.</p> |
|  | <p>The cabin cannot be started via the KLAFS Sauna app and bathing parameters cannot be changed if a setting has been changed on the controller or the sauna door has been opened during the remote-control standby period.</p> |



7. Controller

7.5. Touchscreen - Section 1: Cabin control without door contact switch

| Symbol: | Display/function: |
|---|--|
|  | <p>The controller can only be operated via the Klafs Sauna app if an installed and activated WLAN is available.</p> <ul style="list-style-type: none"> ▶ See page 14 for the WLAN function. |
|  | <p>Cabin control.</p> <ul style="list-style-type: none"> ☞ Function for operating the controller via the Klafs Sauna app, e.g. with a smartphone. <p>Carry out a visual precheck of the inside of the cabin to ensure that there are no flammable objects near the sauna heater or the infrared heater. The cabin can only be started via the Klafs Sauna app if this visual check has been carried out after the last sauna session.</p> <ul style="list-style-type: none"> ☞ Ensure that no unauthorised persons entered your sauna cabin during your absence. |

7. Controller

7.6. Touchscreen - Section 2: Bathing modes

| Symbol: | Display/function: |
|---|---|
|  | <p>Sauna mode.</p> <p>➤ See page 22.</p> |
|  | <p>PUR bathing mode.</p> <p>☞ Only available with the Sauna bathing mode.</p> <p>When the PUR symbol appears, the cabin has reached the correct temperature for the PUR bathing mode and it can be switched on.</p> <p>Once the PUR bathing mode has been switched on, the oven heating is switched off. The heat stored in the sauna stones is released.</p> <p>➤ See page 23.</p> |
|  | <p>InfraPLUS mode.</p> <p>➤ See page 24.</p> |

7. Controller

7.7. Touchscreen - Section 3: Status bar







The status bar is for display only and has no touchscreen functions.
The symbol display depends on the configuration.

| Symbol: | Display/function: |
|-------------|---|
| | WLAN is installed and activated. The dot inside the symbol indicates that a WLAN module is installed. The waves appear if there is a connection between the controller and a router. |
| | Green Sauna is activated. The function is switched on/off via a separate touch key on the sauna. When the Green Sauna function is switched on, any units that are not required can be switched off. The cover flap of the ventilation system is closed. |
| | Lit: Subsequent drying is activated. (Optional) Flashing: Low water level. |
| | Voice control is activated. |
| | Output from the sauna heater is requested via the key switch. The key symbol is displayed for 30 minutes after changing a bathing parameter. Changes to a bathing parameter can be confirmed by pressing the key switch on the sauna cabin within 30 minutes. <input type="checkbox"/> When the key functions are activated, the settings and the key-switch symbol remain displayed (for max. 30 minutes) until the key switch is pressed. |
| | The remote power-on unit is connected. The sauna can be operated via both the remote power-on unit and the control panel. |
| TC | The TOUCHCONTROL is connected. The touchscreen on the controller is locked. |
| ECO | The Climate Manager is connected and in operation. The Climate Manager automatically controls the speed of the fan. |
| IMES | The Klafs IMES-1 is connected. There are no faults in the data exchange between Klafs IMES-1 and the controller. |
| | The controller is in Service mode. |

7. Controller

7.8. Touchscreen - Section 4: Digital display of bathing parameters, digital display of preset time mode, ready-to-use symbol









| Symbol: | Display/function: |
|---|--|
|  | Displays the temperature in digital form. |
|  | Ready-to-use symbol. The inside of the cabin has reached the set temperature. |
|  | Displays the time in digital form. ▶ To set the time, see page 20. |
|  | Displays the remaining bathing time in digital form during a session. |
|  | Displays the pre-programmed start time in digital form. |

7. Controller

7.9. Touchscreen - Section 5: Special features, cabin light, clock







The symbol display depends on the configuration.





| Symbol: | Display/function: |
|---|---|
|  | <p>Touchscreen lock. The controller can only be used after entering your password via the touchscreen.</p> <ul style="list-style-type: none"> ○ Symbol is flashing at 1 Hz = Touchscreen can be used. ○ Symbol appears = Touchscreen is locked. <p>◆ Setting up the touchscreen lock - See Servicing Instructions 18029, 18033, 18040.</p> <p>◆ To switch the touchscreen lock on/off, see page 37.</p> |
|  | <p>Switches the reading light on/off.</p> <p>☞ Reading light switches off after a delay of up to 30 seconds after the bathing program has finished.</p> |
|  | <p>Switches the coloured light on/off.</p> <p>☞ Coloured light switches off after a delay of up to 30 seconds after the bathing program has finished.</p> |
|  | <p>Switches AQUAVIVA on/off.</p> <p>☞ AQUAVIVA switches off after a delay of up to 30 seconds after the bathing program has finished.</p> |
|  | <p>Switches Starry Sky on/off.</p> <p>☞ Starry Sky switches off after a delay of up to 30 seconds after the bathing program has finished.</p> |
|  | <p>Adjusts the fan.</p> <p>◆ To adjust the settings, see page 38.</p> |
| | |
|  | <p>Cabin light.</p> <p>◆ See page 19.</p> |
|  | <p>Sets the time.</p> <p>◆ See page 20.</p> |

7. Controller

7.10. Touchscreen - Section 6: Parameter input, controller with bar scale

| Symbol: | Display/function: |
|---|--|
|  | <p>The bar scale displays the settings in ten bars.</p> <p>The bar scale is used to set parameters such as humidity, music volume, fan speed, scent and InfraPLUS intensity.</p> <ul style="list-style-type: none"> ☞ Set parameters on the bar scale by swiping it with your finger like a slider or by pressing the "+" and "-" symbols to increase or decrease the setting. ☞ The controller will automatically cancel input mode and retain the existing setting if the altered setting is not confirmed by pressing OK within five seconds. |
|  | <p>Minus symbol. Reduces parameter setting.</p> <p>Displayed in digital form or on the bar scale.</p> |
|  | <p>Applies selection.</p> <p>Saves the changed parameter setting.</p> |
|  | <p>Plus symbol. Increases the parameter setting.</p> <p>Displayed in digital form or on the bar scale.</p> |

7.11. Touchscreen - Section 7: Programs, bathing parameters, preset time mode

| Symbol: | Display/function: |
|---|---|
|  | <p>Selecting the standard/custom program.</p> <p>➤ See page 33.</p> |
|  | <p>Setting the temperature.</p> <p>➤ See page 34.</p> |
|  | <p>Setting InfraPLUS.</p> <p>➤ See page 34.</p> |
|  | <p>Setting the bathing time.</p> <p>➤ See page 35.</p> |
|  | <p>Setting preset time mode.</p> <p>➤ See page 35.</p> |

8. Basic functions and settings

8.1. Switching the power supply on/off at the main switch

Switching the power supply on

1. Press button (1).

The controller goes into standby mode.

When the controller is switched on, the following symbols are displayed: Bathing mode, on/off, cabin light and clock.

The controller can now be operated via the touchscreen.

► See page 21 for standby mode.

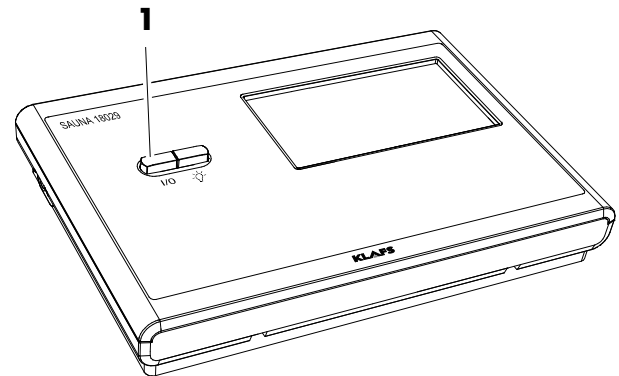

After five minutes of non-use, the backlighting will gradually start to dim and then the screen will switch off fully within a minute. If you touch the display while it is dimmed or switched off, the backlighting will switch on first. You will then be able to operate the controller via the display.

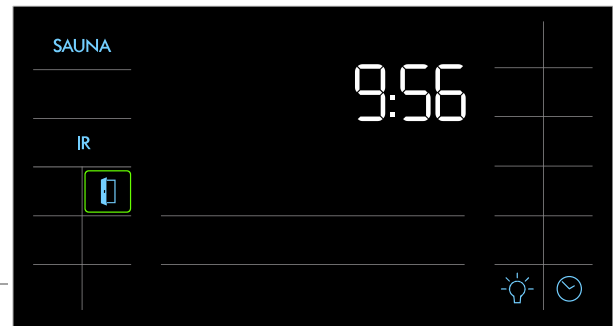

Switching the power supply off

1. Press button (1).

The touchscreen is blank when the controller is switched off.

- ☞ The cabin light can be switched on even when the controller is switched off.
- ☞ The clock keeps running.

8. Basic functions and settings

8.2. Switching the cabin light on/off

1. Press button (1).
2. Or press the symbol (2) if the controller is switched on.

The cabin light switches on or off.

- ☞ The cabin light can be switched on by pressing button (1) even when the main switch is off.

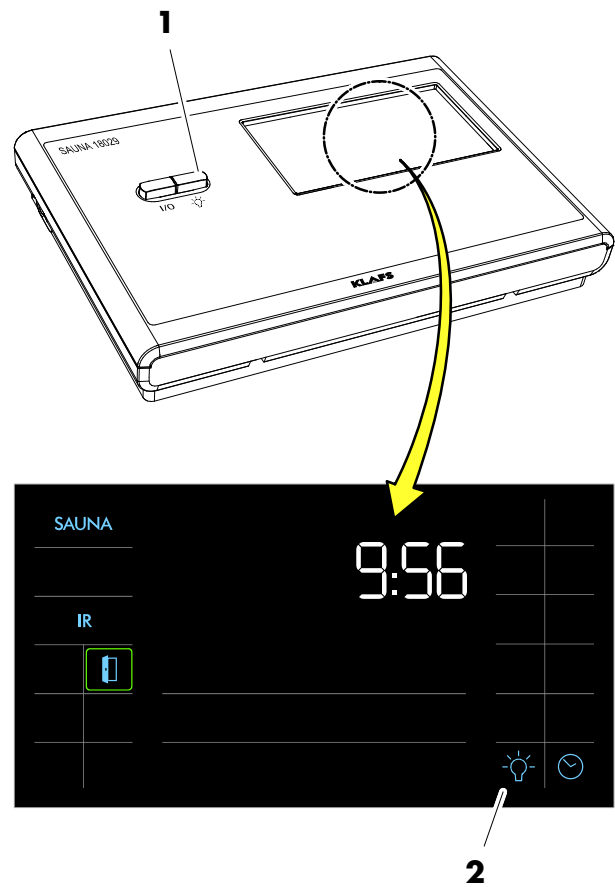

8. Basic functions and settings

8.3. Setting the time

1. Press the symbol (1) or (2).

The digits for the hour start flashing.

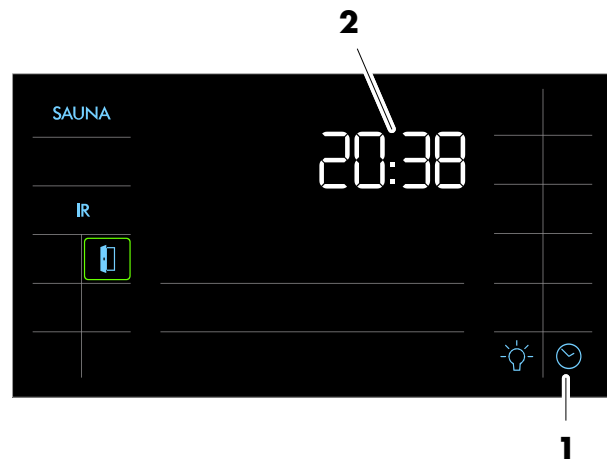

2. Set the hour by pressing the +/- symbols.

3. Confirm the set hour by pressing the OK symbol.

The digits for the minutes start flashing.

4. Set the minutes by pressing the +/- symbols.

5. Confirm the set hour by pressing the OK symbol.

The time has been set.



☞ The controller will automatically cancel input mode and retain the existing setting if the altered setting is not confirmed by pressing OK within five seconds.

☞ The internal clock has a power reserve for a few months in the event of a power failure.

8. Basic functions and settings

8.4. Standby mode

The touchscreen displays the following symbols in standby mode:

- Sauna (1)
- InfraPLUS (2)
- Time (3)
- Setting the time (4)
- Cabin light (5)
- Cabin control with (lit) backlit ring (6) (optional).

The backlighting switches off automatically after five minutes of non-use.

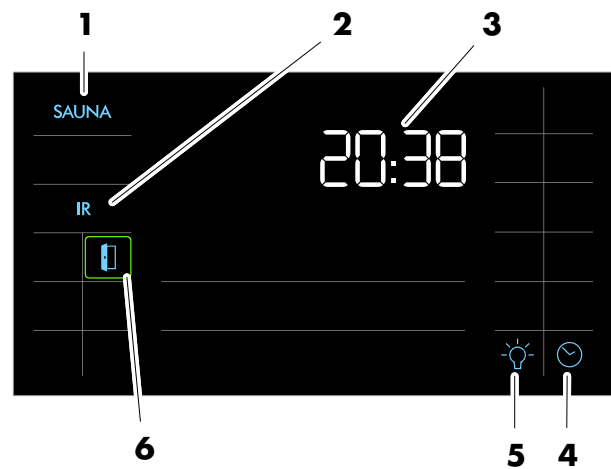

- ◆ Function for remotely controlling the controller via the Klafs Sauna app e.g. on a smartphone, see page 11. Cabin control.

- ☞ The controller can be operated via the touchscreen at any time whilst in standby mode.



The cabin control function for remotely controlling the controller via the Klafs Sauna app is only available for cabins that have WLAN installed and activated.

- ◆ See page 14 for the WLAN function.

9. Operation

9.1. Sauna mode



Risk of fire!

Before commissioning the controller, always check that there are no flammable objects on or near the sauna heater or on the infrared heater.



On models with a key switch (optional), changes to bathing parameters in the sauna cabin must be confirmed by pressing the key switch within 30 minutes. The key switch symbol in the display goes out after confirmation.

Starting Sauna mode

1. Press the symbol (1).

The bathing parameters flash for approx. three seconds. After that, the last program used for the selected bathing mode is automatically started.

The backlit ring for SAUNA is displayed.

The sauna heater switches on and the cabin heats up.

Once the cabin has reached the preset temperature, the symbol (2) appears. The cabin is ready to use.

- ◆ If you would like to start a stored program for the selected bathing mode, see page 33.
- ◆ To change the temperature, see page 34.
- ◆ To change the bathing time, see page 35.

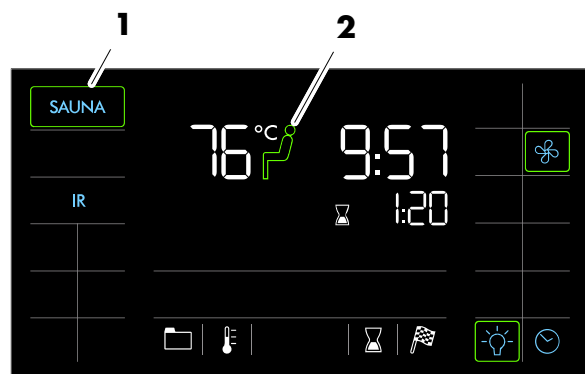
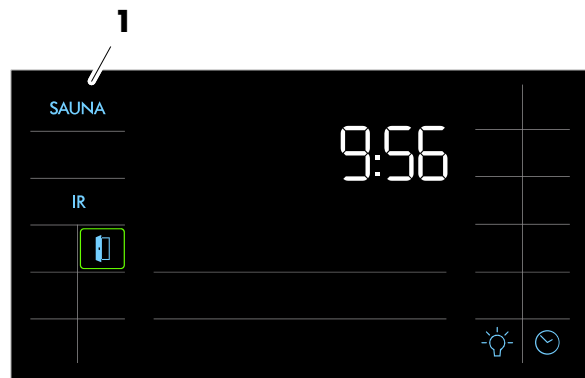

Stopping Sauna mode

1. Press the symbol (1).

The bathing mode is cancelled.

The backlit ring goes out.

The controller then goes into standby mode.

9. Operation

9.2. PUR bathing mode



The PUR bathing mode is only available with the Sauna bathing mode.

Starting PUR bathing mode

To start the PUR bathing mode, the Sauna bathing mode must be started and the cabin must reach the preset temperature.

Once the preset temperature has been reached, the symbol (1) appears.

1. Press the symbol (1).
The bar for PUR is displayed.

- ☞ During PUR operation, the sauna heater is switched off.
- ☞ The heat stored in the sauna stones is released.
- ☞ After approximately 20 minutes, or once the temperature in the sauna cabin has decreased by approximately 15 °C, the PUR bathing mode stops automatically. The sauna heater begins heating again.

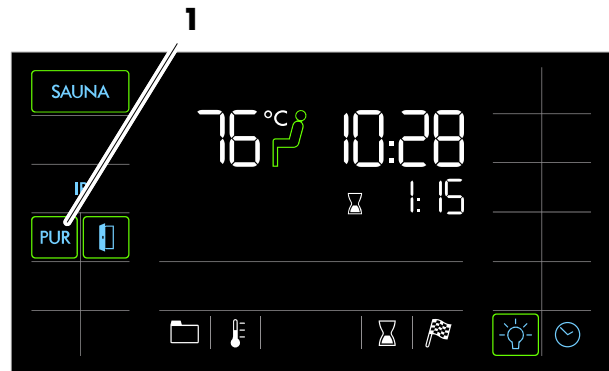

Stopping the PUR bathing mode

1. Press the symbol (1).

The bar and the PUR symbol go out.

The sauna heater begins heating again.



9. Operation

9.3. InfraPLUS mode (optional)



Risk of fire!

Before commissioning the controller, always ensure that there are no flammable objects near the sauna heater or infrared heater in the cabin.



On models with a key switch (optional), changes to bathing parameters in the sauna cabin must be confirmed by pressing the key switch within 30 minutes. The key switch symbol in the display goes out after confirmation.

Starting InfraPLUS

1. Press the symbol (1).

The bathing parameters flash for approx. three seconds. After that, the last program used for the selected bathing mode is automatically started.

The backlit ring for InfraPLUS is displayed.

The sauna heater and the InfraPLUS infrared heater switch on. The cabin heats up.

☞ The infrared heater will not switch on if the cabin temperature is over 50 °C, e.g. due to a previous sauna on SANARIUM session.

Once the cabin has reached the preset temperature, the symbol (2) appears. The cabin is ready to use.

- ◆ If you would like to start a stored program for the selected bathing mode, see page 33.
- ◆ To change the InfraPLUS intensity, see page 34.
- ◆ To change the bathing time, see page 35.

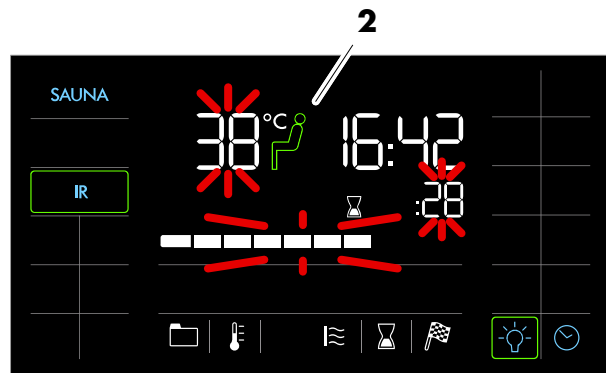

Continued on the next page

9. Operation

9.3. InfraPLUS mode (optional)

Continued

Starting InfraPLUS

2. Step inside the cabin and put the backrest into position:
Raise the backrest, swing it out and then set it down on the bench.
3. Place a towel down where you will sit.
4. Sit down in front of the infrared heater with a naked upper body.

☞ The infrared heater is controlled by measuring the skin's temperature (SensoCare).



SensoCare:

- Fully automatic heat intensity control
- Sensors integrated into the infrared heater
- Protects the skin against high temperatures
- SensoCare measures the skin temperature at four locations without touching the skin, and automatically starts the infrared heater (if the upper body is unclothed)
- Gentle heating occurs on several levels.

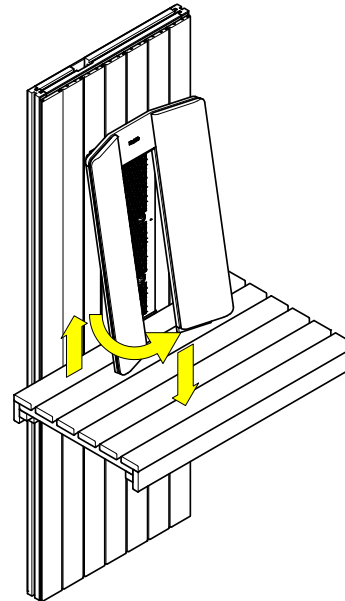

Restarting InfraPLUS mode

☞ Stand up from the infrared seat and wait at least ten minutes before sitting down again. After you have sat down again, wait until the infrared heaters switch on again and the remaining program time is displayed.

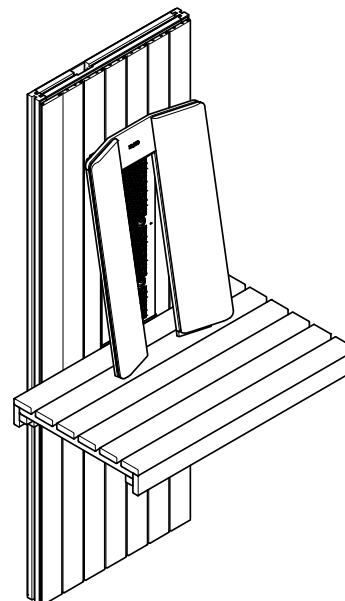

Continued on the next page

9. Operation

9.3. InfraPLUS mode (optional)

Continued

Stopping InfraPLUS

1. Press the symbol (1).

The bathing mode is cancelled. The backlit ring goes out.

Automatic follow-on program after using InfraPLUS mode

1. On models with wall-mounted air extractor control: Set air extractor opening to position 4.
- ☞ If InfraPLUS was used for more than ten minutes, the follow-on program will start automatically after ending the program. Symbol (2) is displayed. The remaining program time before the follow-on program starts is displayed digitally (3).
 - ☞ The sauna heater heats up again, causing an increased exchange of air. This ventilates the cabin.
 - ☞ The controller automatically goes into standby mode after the follow-on program has finished. The time appears on the display.

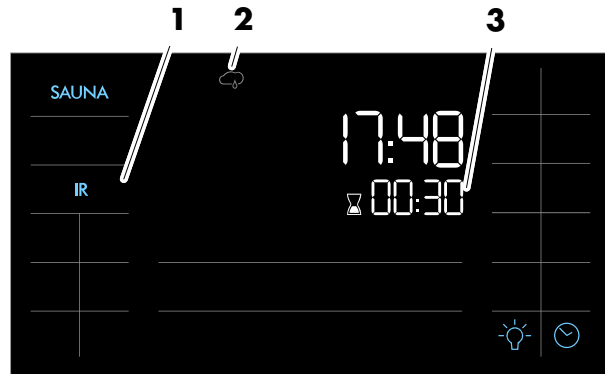

Airing the cabin

- ☞ After using the Sauna/SANARIUM/InfraPLUS mode or follow-on program, air the cabin by opening the cabin door.
- ☞ Open the vent flap (optional) fully when airing the cabin (4).

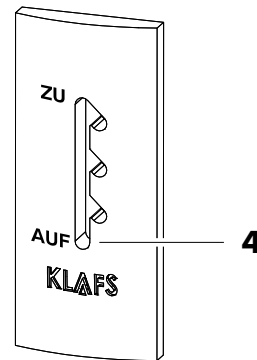

9. Operation

9.4. Remote power-on unit (optional)

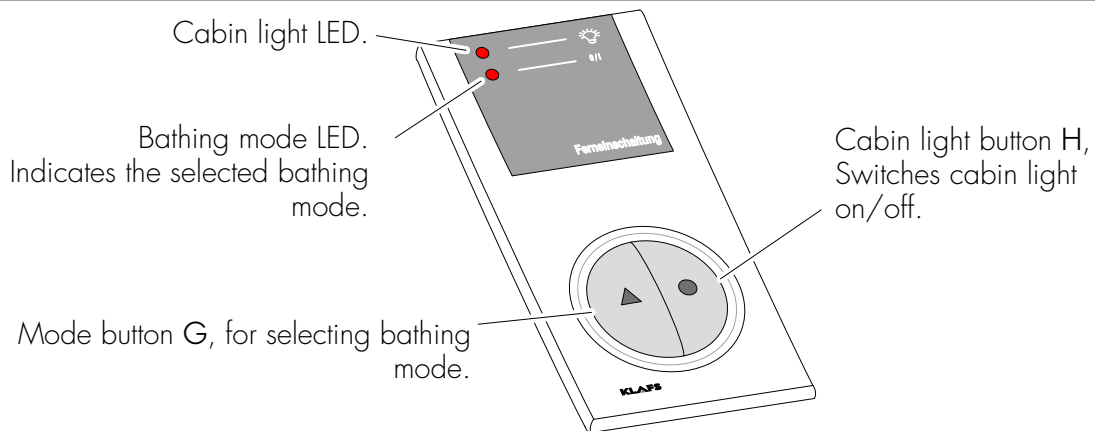

The remote power-on unit is available as an optional extra. Please see delivery documents for scope of supply.

Function

The remote power-on unit is used for:

- Starting and stopping the Sauna bathing modes
- Switching the cabin light on and off.

The symbol  appears in the control panel display when the remote power-on unit is connected.

- ☞ The cabin light and the bathing mode can be operated independently of each other on the remote power-on unit and the controller.

Switching the cabin light on/off

1. Press the cabin light button H .
- ☞ The cabin light cannot be switched off during use.

Switching bathing mode on/off



Risk of fire!

Before commissioning the controller, always check that there are no flammable objects on or near the sauna heater or on the infrared heater.

1. Switch on the main switch on the controller.
2. Press the mode G  button. The LED for the selected bathing mode lights up.
3. The selected program starts automatically three seconds after the last time a button is pressed.

9. Operation

9.5. Interior display (optional), with SAUNAPUR button, with/without IR receiver

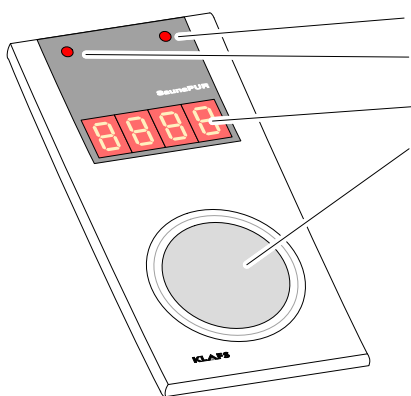

- IR-receiver LED.
- SaunaPUR bathing mode LED active/inactive.
- Seven-segment display.
- SaunaPUR button. Start/stop the PUR bathing mode.

Displayed when operating via remote control (optional).

| | |
|--|-------|
| Sauna - time | 19.21 |
| Sauna - actual temperature | 95°C |
| Target temperature | t 100 |
| Remaining bathing time | 325 |
| Switch status on/off | OFF |
| End of program | End. |
| Temperature for SaunaPUR bathing mode not yet reached or not available using IR remote control function. | -no- |

Please see delivery documents for scope of supply.

Display function

The four-digit seven-segment display alternates between the following:

- Time
- Actual temperature
- Target temperature
- Remaining bathing time
- Switch status
- End of program.

Function of the SaunaPUR button

Start or stop the PUR bathing mode.

- ☞ To start the PUR bathing mode, the Sauna bathing mode must be started and the cabin must reach the preset temperature.

Continued on the next page

9. Operation

9.5. Interior display (optional), with SaunaPUR button, with/without IR receiver

Continued

Starting the SaunaPUR bathing mode

- ☞ Prerequisite: The target temperature must be reached. The  symbol must appear in the display.
- ▶ If necessary, start the Sauna bathing mode, see page 22.
- ☞ It is possible to start the SAUNAPUR bathing mode using the controller or on the interior display (optional).
 1. Press the SaunAPUR bathing mode button.
- ☞ If "no" appears in the seven-segment display, wait until the temperature for the SAUNAPUR bathing mode has been reached. Then try again.
- ☞ When the SAUNAPUR bathing mode is active, the SaunaPUR bathing mode LED lights up.
- ☞ After approximately 20 minutes, or once the temperature in the sauna cabin has decreased by approximately 1.5 °C, the SAUNAPUR bathing mode stops automatically. The sauna heater begins heating again.

Stopping the SaunaPUR bathing mode

1. Press the SaunAPUR bathing mode button.
- ☞ The SAUNAPUR bathing mode LED goes out. The sauna heater begins heating again.

9. Operation

9.6. Green Sauna button

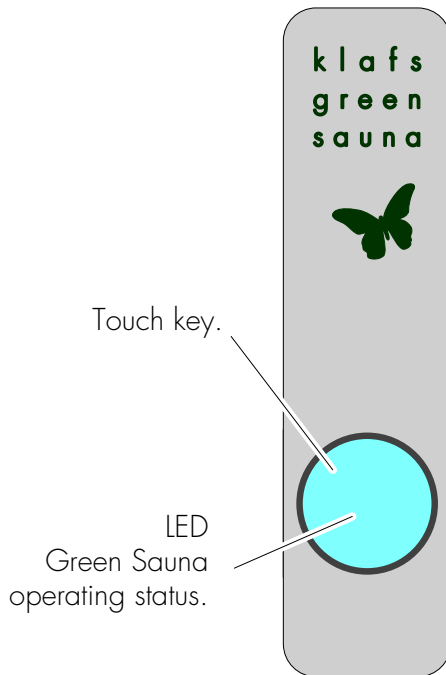

Green Sauna operating status:

LED lights up green = Green Sauna active.
No bathing session.
Devices that are not required can be switched off.

LED lights up blue = Green Sauna on standby.
Bathing session.
Devices that are required can be switched on.

- ☞ The Green Sauna function is switched on automatically after switching on the power supply for the sauna cabin. The LED lights up green.

Switching on the Green Sauna function

- ☞ Devices that are not required can be switched off when you leave the sauna cabin.

1. Press the touch key. The LED lights up green.

The Green Sauna is active.

Switching off the Green Sauna function

- ☞ Devices that are required can be switched on when you enter the sauna cabin.

1. Press the touch key. The LED lights up blue.

The Green Sauna goes into standby mode.



The colour of the LED operating status button on the Green Sauna will not change when the Green Sauna function is switched on or off via voice control.

9. Operation

9.7. WELLCONTROL (optional)



WELLCONTROL allows you to operate the sauna controller via the interior display with infrared sensor.

AQUAVIVA, Starry Sky, coloured light and reading light switch off after a delay of up to 30 seconds after the bathing program has finished.

WELLCONTROL button functions:

1. Changes the temperature.
☞ Option: With SANARIUM controller only.
2. Changes the humidity.
☞ Option: With SANARIUM controller only.
3. Changes the bathing time.
☞ Option: With SANARIUM controller only.
4. Starts Sauna mode.
☞ The last-selected program is started.
5. Starts SANARIUM mode.
☞ Option: With SANARIUM controller only.
☞ The last-selected program is started.
6. Switches the cabin light on/off.
7. Switches the reading light on/off.
☞ IMES-1 required.
8. Ends the bathing session.
9. Activates SaunaPUR mode.
10. Switches AQUAVIVA on/off.
☞ CAN connection required.
11. Switches the coloured light on/off.
☞ IMES-1 required.
12. Switches Starry Sky on/off.
☞ CAN connection required.
13. Switches the fan on/off.

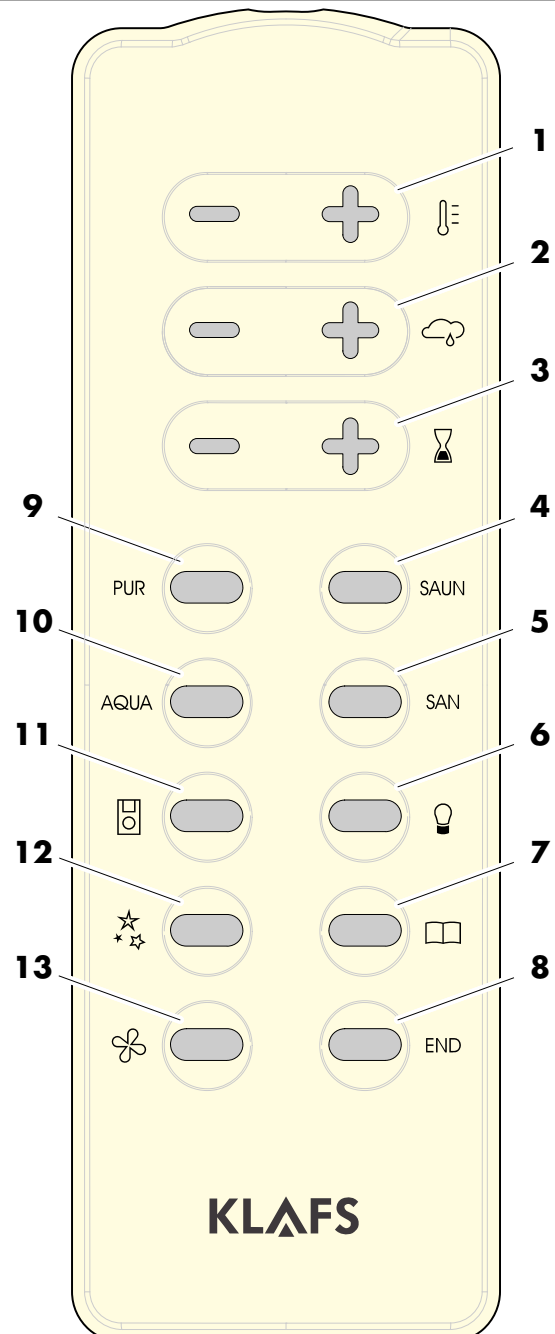

Continued on the next page

9. Operation

9.7. WELLCONTROL (optional)

Continued

Display examples on the interior display with infrared sensor

The interior display shows the control and adjustment functions that have been set using WELLCONTROL.

(Option: SANARIUM controller)

Target humidity F 10

Target temperature t 100

Remaining bathing time 325

Switch status on/off OFF

End of program End.



Battery replacement

Only use batteries with a temperature rating up to 130 °C.

Batteries that have a lower temperature rating may leak or cause an exothermic oxidation reaction (explosion).

Battery brand Tadiran, type: SL-560/S.

Can be ordered from Klafs, for example, with the item number 30601167.

10. Custom settings

10.1. Selecting the standard/custom program



For the Sauna and InfraPLUS* (optional) bathing mode, there is a custom program (Pr 1) available in each case for personalised bathing parameter settings (temperature, intensity* and bathing time).

For the Sauna bathing mode, there are three standard programs and for the InfraPLUS* bathing mode (optional), there are four standard programs with fixed bathing parameter settings available.

Changes to the bathing parameters are automatically saved to the custom program (Pr 1) for the bathing mode selected.

If the personalised bathing parameter settings are the same as the settings in one of the standard programs, the standard program is automatically selected.

☞ *) The "intensity" bathing parameter is only available with the InfraPLUS bathing mode (optional).

Selecting and starting a program

☞ Requirement: Select the desired bathing mode by pressing the Sauna or InfraPLUS* symbol.

1. Press the symbol (1).
2. Select the desired program by pressing the +/- symbols (2).

The storage location of the selected program (3) is displayed.

The stored bathing parameters such as temperature, intensity* and bathing time are displayed for the program selected.

3. Start the selected program by pressing the OK symbol (4).

☞ The controller will automatically cancel input mode and retain the existing setting if the altered setting is not confirmed by pressing OK within five seconds.

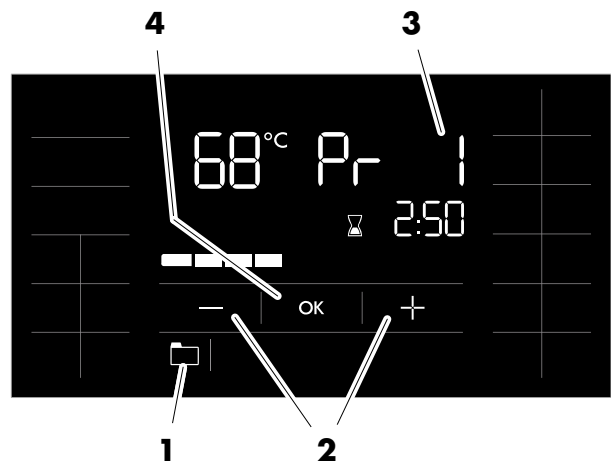

Sauna program - temperature:

| | | | | | | | |
|---|----------------|---|-------|---|-------|---|-------|
| 1 | Custom program | 2 | 80 °C | 3 | 90 °C | 4 | 95 °C |
|---|----------------|---|-------|---|-------|---|-------|

InfraPLUS (optional)

| Bathing time | | Intensity | |
|--------------|----------------|-----------|---------------------------|
| 1 | Custom program | 1 | Custom program |
| 2 | 20 minutes | 2 | Bar scale 2 ≙ Soft |
| 3 | 25 minutes | 3 | Bar scale 6 ≙ Medium |
| 4 | 30 minutes | 4 | Bar scale 10 ≙ Intensive |

10. Custom settings

10.2. Setting the temperature

Changing the temperature

1. Press the symbol (1) or (2).

The temperature display (2) starts flashing.

2. Set the desired temperature by pressing the +/- symbols (3).
3. Apply the set temperature by pressing the OK symbol (4).

- ☞ The controller will automatically cancel input mode and retain the existing setting if the altered setting is not confirmed by pressing OK within five seconds.

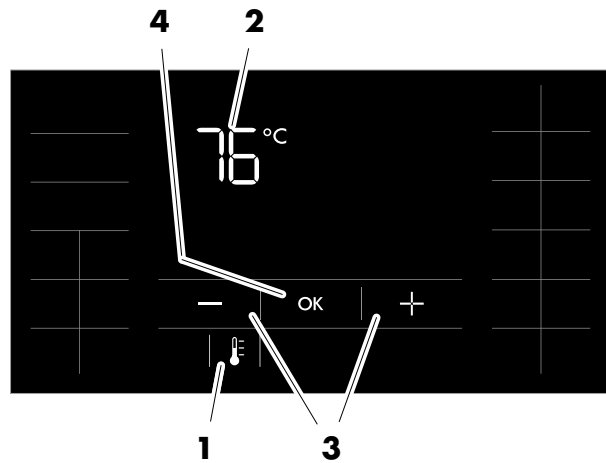

10.3. Setting InfraPLUS (optional)

Changing the intensity

1. Press the symbol (5) or (6).

The intensity bar scale (6) flashes.

2. Set the desired intensity by pressing the +/- symbols (3).
3. Apply the set intensity by pressing the OK symbol (4).

- ☞ The controller will automatically cancel input mode and retain the existing setting if the altered setting is not confirmed by pressing OK within five seconds.

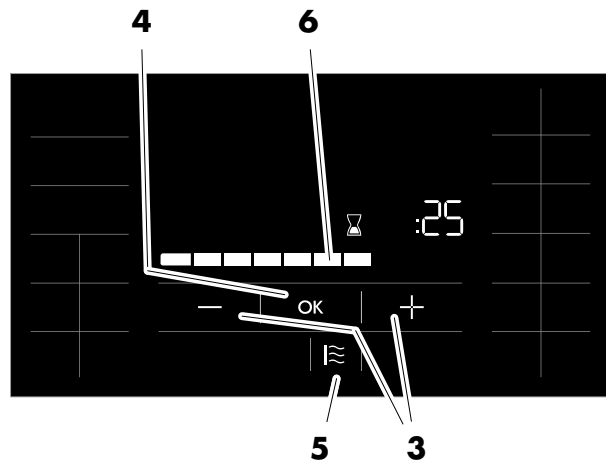

10. Custom settings

10.4. Setting the bathing time



In InfraPLUS mode the bathing time can be set to between five and 30 minutes to the nearest minute.

Changing the bathing time

1. Press the symbol (1) or (2).

The digits for the hour (2) start flashing.

2. Set the desired bathing time (separately for hours and minutes) by pressing the +/- symbols (3).
3. Apply the set bathing time by pressing the OK symbol (4) in each case.

- ☞ The controller will automatically cancel input mode and retain the existing setting if the altered setting is not confirmed by pressing OK within five seconds.

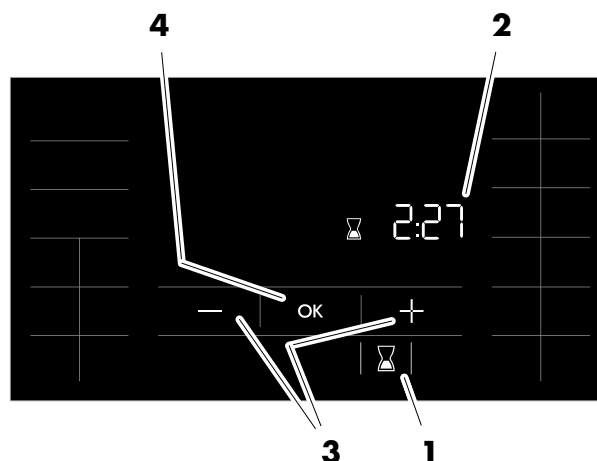

10.5. Setting preset time mode



Risk of fire!

Before commissioning the controller, always ensure that there are no flammable objects near the sauna heater or infrared heater in the cabin.

Programming the pre-programmed start time

1. Press the symbol (5).

The pre-programmed start time (6) starts flashing.

2. Set the desired pre-programmed start time (hour and minutes) by pressing the +/- symbols (7).
3. Apply the set pre-programmed start time (hour and minutes) by pressing the OK symbol (8) in each case.

- ☞ The controller will automatically cancel input mode and retain the existing setting if the altered setting is not confirmed by pressing OK within five seconds.

- ☞ The controller goes into standby mode and starts heating automatically before the set time.

- ☞ The sauna cabin is ready to use at the programmed time.

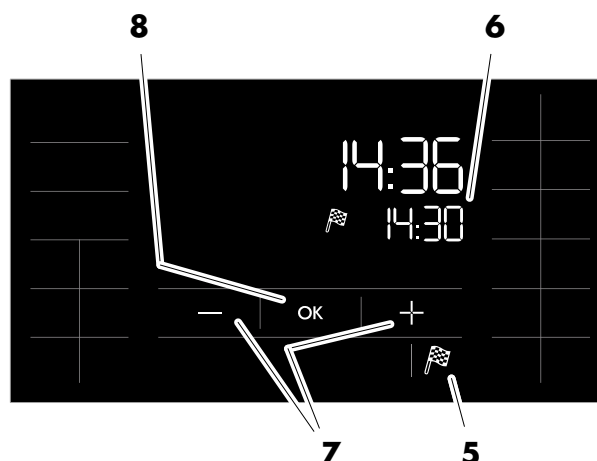

10. Custom settings

10.6. Setting a new password for the touchscreen lock



The default password is 1111.



- ☞ Requirement:
The touchscreen lock must have been activated on service menu option 25 LOCK.
- ▶ See Servicing Instructions 18029, 18033, 18040.

Setting a new password

1. Press the symbol (1) twice, pausing for one second between presses.
☞ The default password is 1111.
2. Enter the old password (4) (1111 in this example) one digit at a time by pressing the +/- symbol (2) and pressing the OK symbol (3) to confirm in each case.

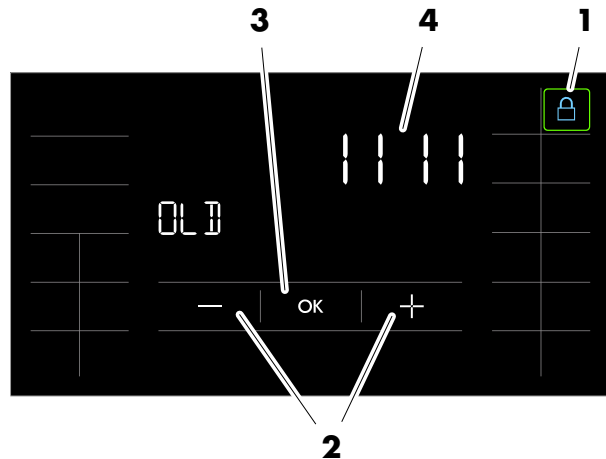

3. Enter the new password (5) (2222 in this example) one digit at a time by pressing the +/- symbol (2) and pressing the OK symbol (3) to confirm in each case.



4. Enter and confirm the new password (5) again (2222 in this example).

- ☞ If the password is entered incorrectly, the message ERR appears.



10. Custom settings

10.7. Switching the touchscreen lock on/off



If the touchscreen lock is active (padlock symbol (1) displayed), the controller cannot be operated via the touchscreen.



- ☞ Requirement:
The touchscreen lock must have been activated on service menu option 25 LOCK.
- ◆ See Servicing Instructions 18029, 18033, 18040.

Switching the touchscreen lock off

1. Press the symbol (1).
2. Enter the password one digit at a time by pressing the +/- symbol (2) and pressing the OK symbol (3) to confirm in each case.

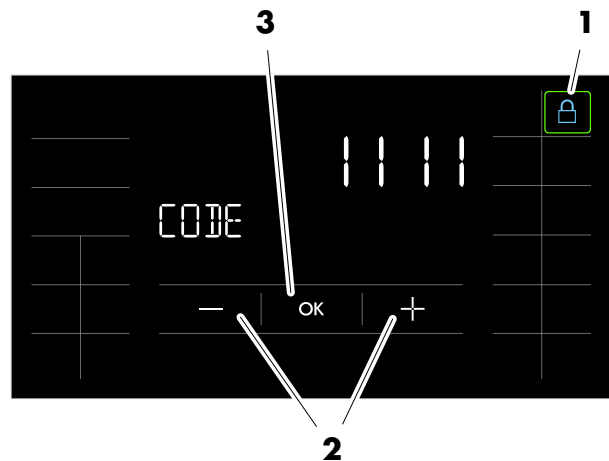

- ☞ Symbol (1) starts flashing at 1 Hz if the correct password is entered.

The touchscreen lock is switched off.

The controller can be operated via the touchscreen.

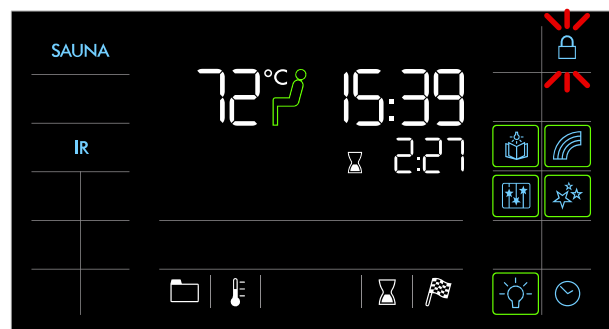

Switching the touchscreen lock on

- ☞ Symbol (1) starts flashing at 1 Hz when the lock is switched off.

1. Press the symbol (1).

Symbol (1) is permanently displayed. The touchscreen lock is switched on.

The controller cannot be operated via the touchscreen.



10. Custom settings

10.8. Special features

Switching special features on

1. Press the relevant symbol (1).

The special feature is switched on.

The bar appears.

Switching special features off

1. Press the relevant symbol (1).

The special feature is switched off.

The bar goes out.

Switching on and setting adjustable special features

1. Change the settings for the adjustable special features (5) by pressing the +/- symbols (2).
2. Or touch the bar scale (3) to change the setting in the same way as for numerical settings.
- ☞ Setting the adjustable special features (5) to 0 switches them off.
3. Apply the changed setting by pressing the symbol (4).

The bar appears.

The adjustable special feature (5) then starts with the setting entered.

Switching adjustable special features off

1. Change the settings for the adjustable special features (5) to 0 by pressing the +/- symbols (2).
2. Or change the setting to 0 by touching the bar scale (3).
3. Apply the changed setting by pressing the symbol (4).

The adjustable special feature (5) is switched off.

The bar goes out.

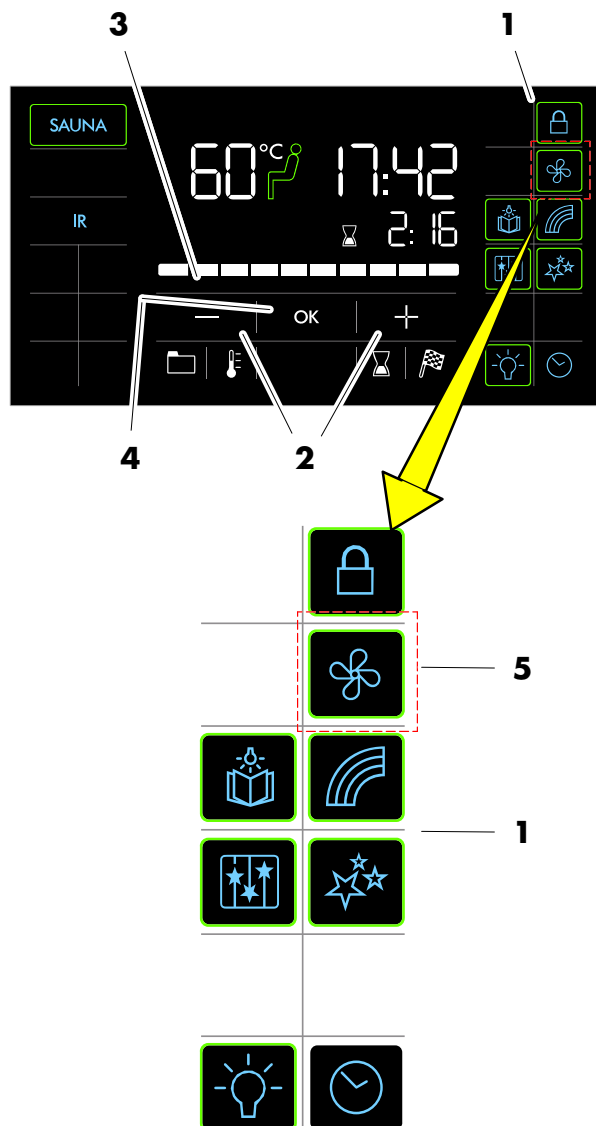

10. Custom settings

10.9. Climate Manager (optional)



Suitable scents

Do not use any scents containing eucalyptus when using the Climate Manager. Use original Klafs scents only.

Operation LED (1) on the Climate Manager.
BCD switch (2) on the Climate Manager.
Adjust the air flow rate inside the sauna cabin.

| Position | Effect: |
|----------|---|
| 0 | <ul style="list-style-type: none"> ○ minimum air flow rate ○ maximum energy savings |
| 9 | <ul style="list-style-type: none"> ○ maximum air flow rate ○ low energy savings |

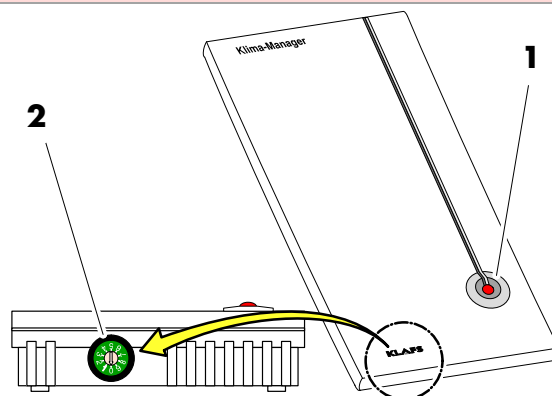

10.10. Vent flap for airing and ventilating the cabin (optional)

Correct airing and ventilation ensure an optimum climate. The Klafs vent wall with adjustable vent flap (optional) allows you to regulate the air flow and volume.

Ventilation: Heating mode

Vent flap, level 1
There is only a low air flow at this setting.

Ventilation: Sauna mode

Vent flap, level 4
Session with maximum number of users.
There is maximum air flow at this setting.

The higher the air flow rate, the better the sauna climate. Intermediate levels can be selected depending on the number of users.

However, you must distinguish between Sauna, SANARIUM or InfraPLUS (optional) mode.

Sauna:

Vent flap, level 4 to 3.

InfraPLUS:

Vent flap, level 1 to 2.

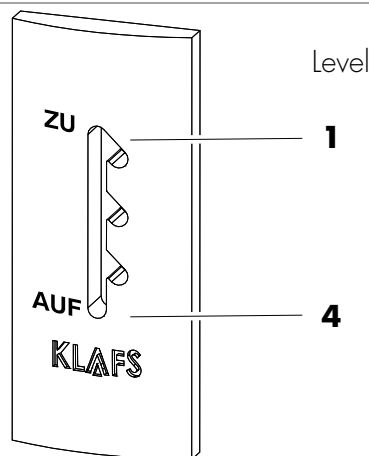

11. If something does not work

11.1. Error messages on the display



Risk of personal injury and damage to property

Repairs and maintenance must only be carried out by Klafs service engineers or by technicians expressly authorised by Klafs.
Klafs can only provide repairs and servicing work under warranty if this work is carried out by Klafs service engineers.

Error messages

The Service symbol (1) appears together with the error message number (2) (e.g. 97).

The controller may still be operational while the Service symbol is flashing, depending on the nature of the fault.



| No. | Fault | How to rectify the fault |
|-----|--|---|
| 69 | The basic heat sensor in the InfraPLUS heater is missing or defective. | Stop using InfraPLUS mode. ▶ Contact Klafs service engineers. |
| 70 | The skin temperature sensors in the InfraPLUS heater are missing or defective. | |
| 72 | A sauna heater cover was detected. | Check the sauna heater and remove any objects. |
| | The cabin door was opened during the heat-up phase. | Close the cabin door. |
| 91 | Safety-contact switch (SCS) has tripped. | Remove the object from the grille above the sauna heater. Check whether the grille has been removed. Fit the grille in place, if necessary. |
| 95 | Line break in the actual temperature sensor. | |
| 96 | Line break in the heater temperature sensor. | |
| 97 | The safety temperature limiter (STL) is interrupted. | |
| 98 | Short circuit in the actual temperature sensor. | |
| 99 | Short circuit in the heater temperature sensor. | Switch the controller off at the mains. Do not use the sauna cabin. ▶ Contact Klafs service engineers. |

11. If something does not work

11.2. Other possible errors

| Fault | Cause | Remedy |
|---|-------------------------------------|---|
| The controller cannot be switched on. | No mains power available. | Check the FI switch and the fuse in the power supply. |
| | Fuse SI102 or SI104 has blown. | Replace fuse SI102 (1.6 AT) or SI104 (1.0 AT), or inform Klafs service engineers. |
| The cabin light does not light up after having been switched on. | The bulb is defective. | Change the bulb. 1. Disconnect the controller from the mains. 2. Replace with a bulb of the same wattage. |
| | No mains power available. | Check the FI switch and the fuse in the power supply. |
| | Light fuse SI103 has blown. | Replace light fuse SI103 (0.6 AT) or inform Klafs service engineers. |
| The fan is not working. No power at output AG1. | No mains power available. | Check the FI switch and the fuse in the power supply. |
| | Fuse SI104 has blown. | Replace fuse SI104 (1.0 AT) or inform Klafs service engineers. |
| | The fan is defective. | Replace the fan. 1. Disconnect the controller from the mains. 2. Replace with a fan of the same wattage. |
| | The main switch is not switched on. | Switch on the main switch. |
| No power at output AG2. | Fuse AG2 SI101 has blown. | Replace fuse AG2 SI101 (1.25 AT) or inform Klafs service engineers. |
| | The controller is in standby mode. | Start a bathing mode. |

Continued on the next page

11. If something does not work

11.2. Other possible errors

Continued

| Fault | Cause | Remedy |
|---|--|---|
| The controller cannot be started or operated. TC | The controller is controlled by TOUCHCONTROL. The operating panel is locked. | Turn off TOUCHCONTROL. ☞ After approx. 5 minutes, TOUCHCONTROL activates the controller. |
| | | Disconnect the data lead between the TOUCHCONTROL and the controller. |
| The controller cannot be operated.  | The touchscreen lock symbol appears on the touchscreen. The touchscreen lock is switched on. | Switch the touchscreen lock off. ◆ See page 37. |
| The sauna heater does not heat up (when controlled via TOUCHCONTROL or Central Building Control CBC).  | The additional option (key) appears in the display for 30 minutes. | ☞ Remove flammable objects from the sauna heater. Press the key switch on the sauna cabin for one second within 30 minutes of pressing Start on TOUCHCONTROL or CBC. |
| | The additional option (key) does not appear in the display. Output from sauna cabin heater not requested by CBC. The 30-minute waiting time has elapsed. | Request output from the sauna cabin heater via CBC. |
| | Changes to temperature settings have not been applied. | Press the key switch on the sauna cabin within 30 minutes of changing the settings. |
| Fan cannot be adjusted. | The Climate Manager is connected. | ☞ The air flow rate is regulated by the Climate Manager. |
| The InfraPLUS heaters will not switch on. | The incorrect bathing mode has been selected. | Select InfraPLUS mode. ◆ See page 24. |
| | The temperature in the cabin is greater than 50 °C. | Open the cabin door and allow the temperature to fall. |
| | The InfraPLUS heater is not being supplied with power. | Check the fuse in the power supply. Switch the power supply on. |

Continued on the next page

11. If something does not work

11.2. Other possible errors

Continued

| Fault | Cause | Remedy |
|---|--|---|
| AQUAVIVA does not start. | The mains switch on the AQUAVIVA controller is switched off. | Switch on the mains switch at the AQUAVIVA controller. |
|  | The fuse in the feed line to the AQUAVIVA controller has blown. | Replace or reset the fuse. |
| | The CAN line is interrupted. | Check the CAN line. |
| | The expander circuit board is defective or not plugged in. | Check the expander circuit board and replace if necessary. |
| Starry Sky cannot be switched on. | The mains switch on the Starry Sky controller is switched off. | Switch on the mains switch on the Starry Sky controller. |
|  | The fuse in the feed line to the Starry Sky controller has blown. | Replace or reset the fuse. |
| | The CAN line is interrupted. | Check the CAN line. |
| | The expander circuit board is defective or not plugged in. | Check the expander circuit board and replace if necessary. |
| The coloured light cannot be switched on. | The fuse in the feed line to the coloured light controller has blown. | Replace or reset the fuse. |
|  | The CAN line is interrupted. | Check the CAN line. |
| The reading light cannot be switched on. | The bulb in the reading light is defective. | Replace the bulb in the reading light. Replace with a bulb of the same wattage. |
|  | The electrical connection between the reading light and IMES-1 is interrupted. | Check and secure the electrical connection. |
| Remote power-on symbol. | The controller will not switch on. | On service menu item 20 KEY, change the setting to [2] Remote.  See Servicing Instructions 18029, 18033, 18040. |
|  | | |

11. If something does not work

11.3. Resetting the error message



Notice:

Only allow work on electrical components/assemblies to be carried out by qualified electricians who work in accordance with electrical rules and regulations.

Switch the controller off, disconnect it from the mains and make sure that it cannot be switched on again.

1. Switch the controller off at the main switch (1).
2. Disconnect the controller from the mains and make sure that it cannot be switched on again.
3. Rectify the fault.
4. Reconnect the controller to the mains.
5. Switch the controller on at the main switch (1).

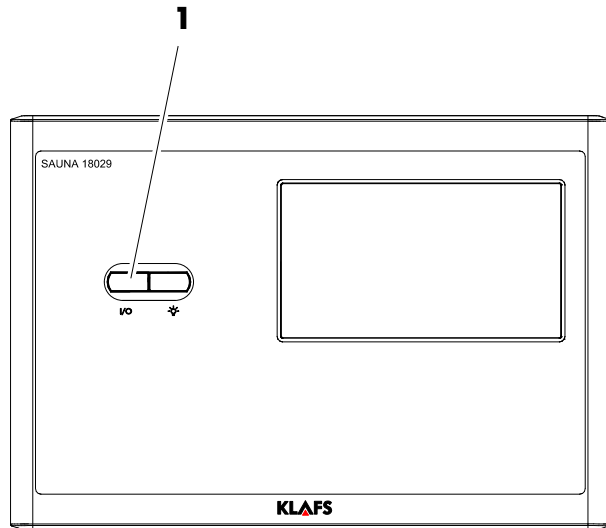

12. Cleaning and maintenance

12.1. Cleaning the sauna cabin

The humidity in SAUNA bathing mode does not damage the wood of your cabin. The cabin should always be aired properly after each session.



Never use a hose or pressure washer on the inner cabin walls, benches or seats.

Dirty benches

Wipe the wooden surfaces with a damp cloth.

Sand any rough surfaces on the benches with fine sandpaper if necessary.

The benches can also be rinsed with a 3 % hydrogen peroxide solution (available from specialist dealers).



Disinfectants are highly corrosive.

It is therefore important to observe to the relevant safety precautions. Always wear rubber gloves when cleaning the cabin.



The outer cabin walls have been varnished or waterproofed.

Do not varnish, paint or waterproof the inner panelling or the inner cabin walls and units (benches, etc.).

12.2. Cleaning the touchscreen

Switch the controller off at the main switch before cleaning.

The touchscreen's surface should only be cleaned using a soft cloth.

Moisten the soft cloth with water.

For more stubborn marks, soak the soft cloth in an organic solvent such as light petroleum.

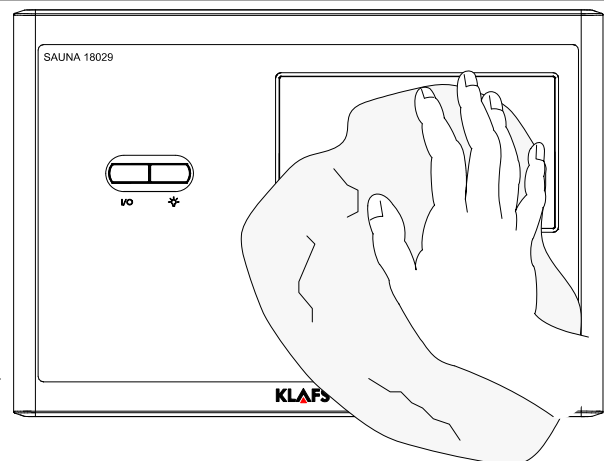

Do not use corrosive solvents such as isopropyl alcohol (IPA).

12. Cleaning and maintenance

12.3. Cleaning the InfraPLUS seat



Never use a hose or pressure washer on the InfraPLUS seat.

Dirty seats

Wipe the wooden surfaces with a damp cloth.

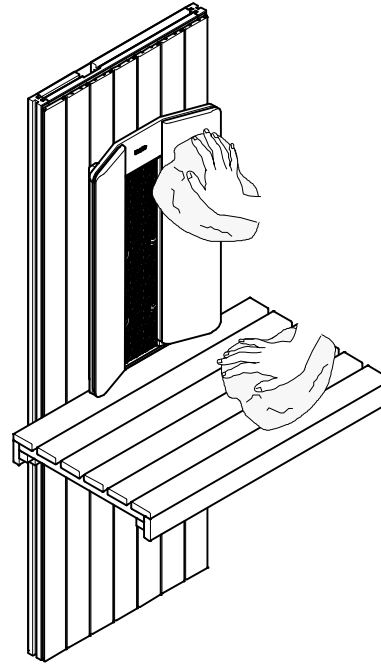

12. Cleaning and maintenance

12.4. Cleaning the InfraPLUS reflector



Hot surfaces.

Before cleaning the InfraPLUS reflector, switch the main switch off and allow the infrared heater to cool.

1. Switch off the main switch.
2. Allow the heating elements in the InfraPLUS reflector to cool.
3. Remove the backrest (1) by lifting it upwards out of the bracket.
4. Unscrew the two screws (2) on the InfraPLUS reflector grille (3). Remove the grille from the front.
5. Clean the InfraPLUS reflector (4) with a damp cloth.
6. Fit the grille by gently bending it into the bracket frame at the top and bottom.
7. Tighten the two screws (2) on the grille (3) securely.
8. Fit the backrest (1) in the bracket from the top.

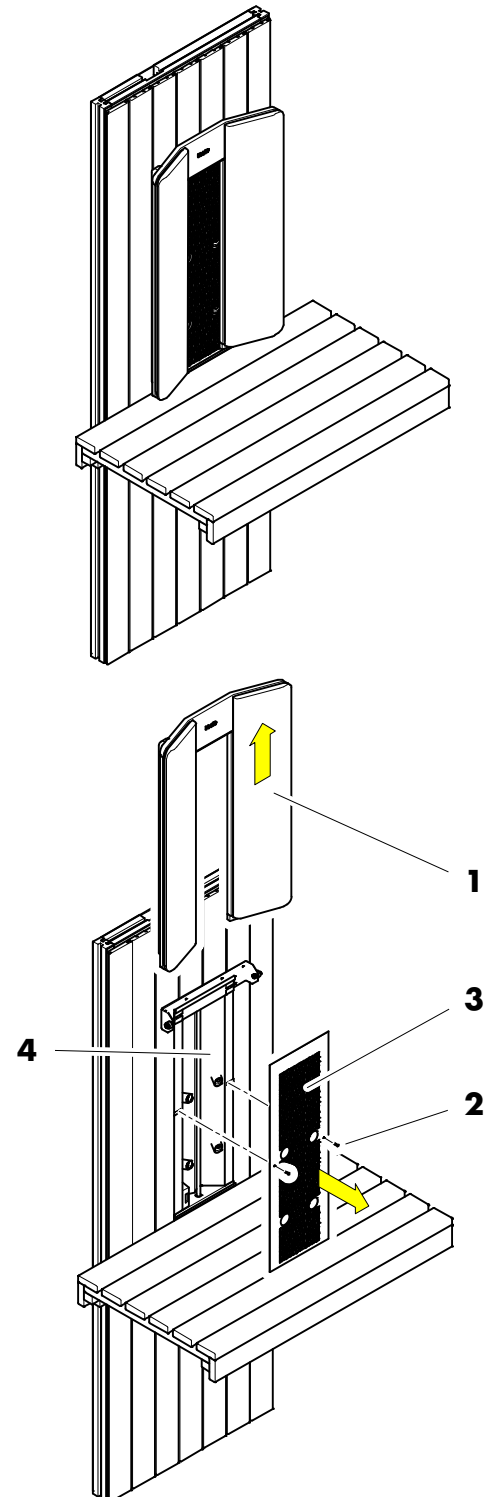

13. Addresses

**Wherever you are: KLAFS is near you.
We provide expert service.**

KLAFS GmbH & Co. KG

Parent company Germany:

Erich-Klafs-Straße 1-3
D-74523 Schwäbisch Hall
Customer Service Tel. +49 791 501-220
Accessories/Spare parts Tel. +49 791 501-310



You can also find
many accessories in
our online shop at
www.klafs.de

Switzerland:

KLAFS AG
Oberneuhofstr. 11
CH-6342 Baar/Zug
Tel. +41 41 760 22 42

Austria:

KLAFS GmbH
Sonnwiesenweg 19
A-6361 Hopfgarten/Tirol
Tel. +43 5335 2330-0

**We hope your "Klafs SaunaPUR with 18029 controller" promotes your
well-being and provides you with hours of fun, leaving you feeling
relaxed and rejuvenated.**

Subject to technical modifications.
Reproduction in whole or in part is prohibited without the written permission of
KLAFS GmbH & Co. KG